



DHE 635... / DHE 645...

en Operating and
Installation instructions



Household Appliances

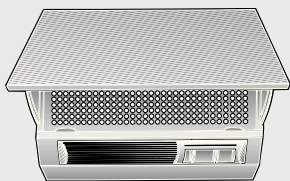

Internet: <http://www.bosch-hausgeraete.de>
Bosch Info-Team: de Tel. 01 80/5 30 40 50 (€ 0,12/Min. DTAG)



BOSCH

GAZ

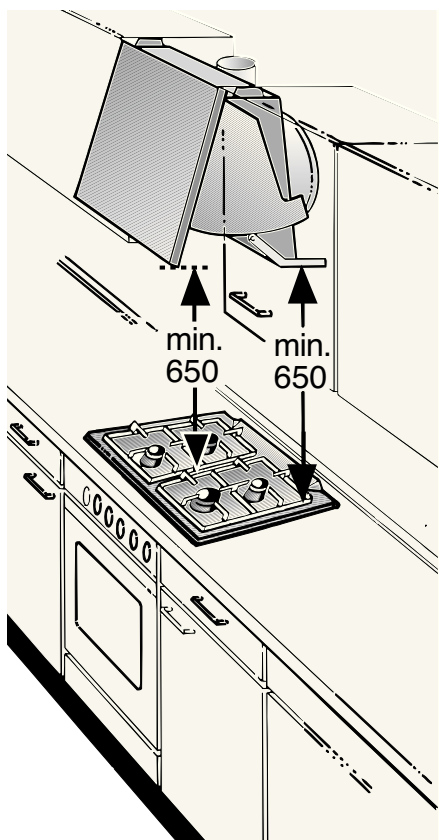

ELECTR.

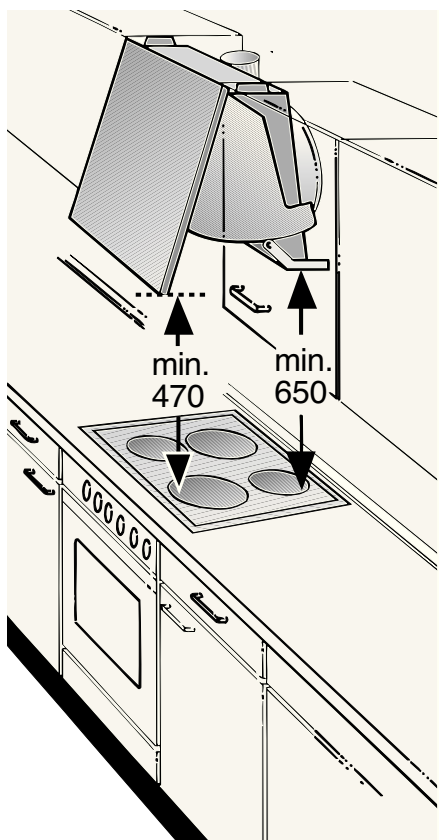

Appliance description

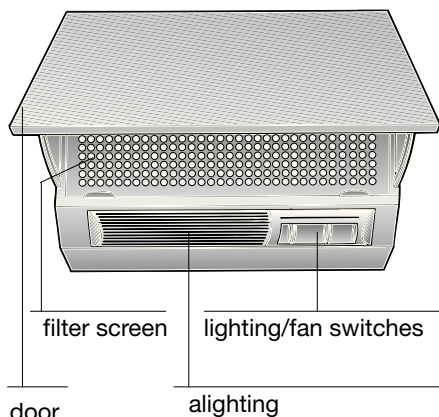

Operating modes

Exhaust-air mode:

- The extractor-hood fan extracts the kitchen vapours and conveys them through the grease filter into the atmosphere.
- The grease filter absorbs the solid particles in the kitchen vapours.
- The kitchen is kept almost free of grease and odours.

If the extractor hood is operated in exhaust-air mode at the same time as a flue-type heater (e.g. gas, oil or solid-fuel heater, instantaneous water heater, boiler), **ensure that there is an adequate air supply**, which the heater requires for combustion.

Safe operation is possible provided that the partial vacuum in the room in which the heater is installed does not exceed 4 Pa (0.04 mbar).

This can be achieved if the combustion air is able to flow through non-lockable openings, e.g. in doors, windows and in conjunction with an air supply/air-intake wall box or by other technical procedures such as reciprocal interlocking.

Operating modes

If the air intake is inadequate, there is a risk of poisoning from combustion gases which are drawn back into the room.

An air-intake/exhaust-air wall box by itself is no guarantee that the limiting value will not be exceeded.

Note: When assessing the overall requirement, the combined ventilation system for the entire household must be taken into consideration. This rule does not apply to the use of cooking appliances, such as hobs and ovens.

Unrestricted operation is possible if the extractor hood is used in recirculating mode – with activated carbon filter.

Circulating-air mode:

- This requires installation of an activated carbon filter (see section on filter and maintenance).
 - The activated carbon filter is obtainable as a special accessory from your **authorized dealer**.
 - The corresponding accessory numbers can be found at the end of these operating instructions.
 - The extractor-hood fan extracts the kitchen vapours, which are purified in the grease filter and activated carbon filter and then conveyed back into the kitchen.
 - The grease filter absorbs the grease particles in the kitchen vapours.
 - The activated carbon filter binds the odorous substances.
- ⚠** If no activated carbon filter is installed, it is not possible to bind the odorous substances in the cooking vapours.

Before using for the first time

Important notes:

- ❑ The Instructions for Use apply to several versions of this appliance. Accordingly, you may find descriptions of individual features that do not apply to your specific appliance.
- ❑ This extractor hood complies with all relevant safety regulations.
- ❑ Repairs should be carried out by qualified technicians only.

Improper repairs may put the user at considerable risk.

⚠ Do not use the appliance if damaged.

⚠ The appliance is not intended for use by young children or infirmed persons without supervision.

Young children should be supervised to ensure they do not play with the appliance.

⚠ If the connecting cable for this appliance is damaged, the cable must be replaced by the manufacturer or his customer service or a similarly qualified person in order to prevent serious injury to the user.

⚠ The appliance may be connected to the mains by a qualified technician only.

⚠ Dispose of packaging materials properly (see Installation instructions).

⚠ This extractor hood is designed for domestic use only.

⚠ Light bulbs must always be fitted when the extractor hood is in use.

⚠ Defective bulbs should be replaced immediately to prevent the remaining bulbs from overloading.

⚠ Never operate the extractor hood without a grease filter.

❑ Before using your appliance for the first time, please read these Instructions for Use carefully. They contain important information concerning your personal safety as well as on use and care of the appliance.

❑ Please retain the operating and installation instructions for a subsequent owner.

⚠ Overheated fat or oil can easily catch fire. If you are cooking with fat or oil, e.g. chips, etc., never leave the cooker unattended.

⚠ Do not flambé food directly under the extractor hood.

Risk of grease filter catching fire due to flames.

⚠ The hotplates must always be covered with a utensil.

⚠ Restrictions apply to the use of the extractor hood over a solid-fuel burner (coal, wood, etc.). (See Installation instructions).

Gas hobs / Gas cookers

⚠ Do not use all the gas hotplates simultaneously for a prolonged period (max. 15 minutes) at maximum thermal load, otherwise there is a risk of burns if the housing surfaces are touched or a risk of damage to the extractor hood.

If the extractor hood is situated over a gas hob, operate the hood at maximum setting if three or more gas hotplates are operated simultaneously.

Using the extractor hood

Kitchen vapour is most effectively eliminated by:

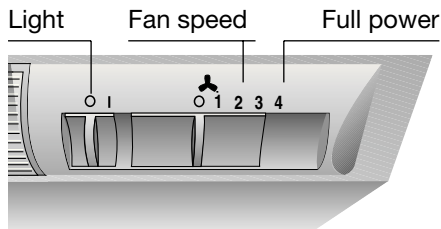
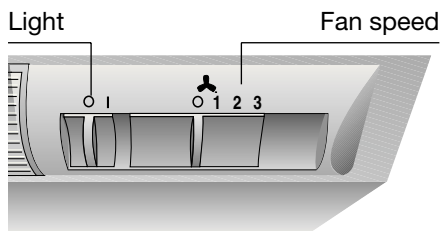
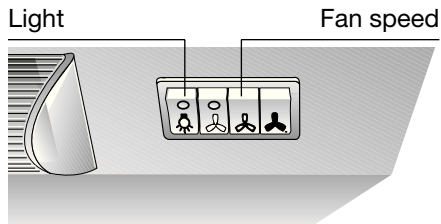
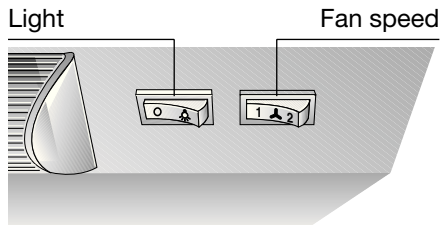

- Switching on the extractor hood** when you start cooking.
- Switching off the extractor hood** a few minutes after you have finished cooking.

Switching on the fan:

- Open the door.
- Select fan speed.

Switching off the fan:

- Close the door.
- When the door is opened out again the fan operates at its last speed setting.

Switching on the fan:

- Open the door.
- Select fan speed.
- Push-and-lock switch for full power.

Switching off the fan:

The extractor hood can be switched off in various ways.

Switching off 1:

- Switch to 0 – switch fan to OFF.

Switching off 2:

- Close the door (switch remains ON).
- To switch ON again just open the door. The extractor hood operates at its last fan speed setting.

Lighting:

The light can be used at any time even when the fan is switched OFF or the door is closed.

Filters and maintenance

Different grease filters can be used to absorb the grease particles in kitchen vapour.

Fleece grease filter:

The filter mat consists of highly flameresistant material.

Attention:

A build up of greasy residue increases flammability, and the function of the extractor hood may be impaired.

Important:

Replace the fleece grease filter in good time, otherwise there is a risk of fire from the heat which accumulates during deep-fat frying or roasting.

Replacing the fleece grease filter:

- During normal operation (daily 1 to 2 hours) the fleece grease filter must be replaced every 8 to 10 weeks.
- Replace printed fleece grease filters at the latest when the coloured print dissolves.

Only use original filters.

- These comply with the safety regulations and ensure optimum function.

Disposal if the old fleece grease filter:

- Fleece grease filters do not contain any harmful substances. They can be disposed of as bio-degradable waste.

Metal grease filters:

The filter mats consist of non-flammable metal.

Attention:

A build up of greasy residue increases flammability, and the function of the extractor hood may be impaired.

Important:

Replace the metal grease filter in good time, otherwise there is a risk of fire from the heat which accumulates during deep-fat frying or roasting.

Cleaning the metal grease filters:

- During normal operation (daily 1 to 2 hours) metal grease filters must be replaced every 8 to 10 weeks.
- The metal grease filter can be cleaned in the dishwasher. Slight discoloration may occur.

Important:

- Do not clean heavily saturated metal grease filters together with kitchen utensils.
- If cleaning by hand, soak the filter mats in a hot soapy solution for several hours. Then brush them off, rinse thoroughly and leave to dry.
- Only use original filters.** These ensure optimum function.

Filters and maintenance

Removal the grease filter:

1. Open door as far as it will go.
2. Push the filter screen up slightly, lift it towards you over the brackets and take it out downwards..

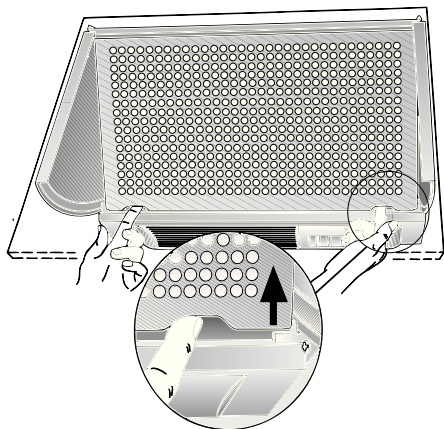

3. Remove the wire grid.

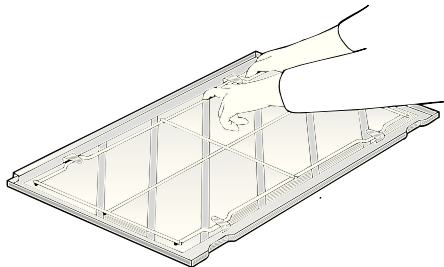

4. Fleece grease filter

Remove saturated filter mat, clean the filter grid and insert new filter mat.

Metal grease filter

Remove saturated filter mats, clean mats and grid. Refit the cleaned filter mats, making sure that there is no gap in the middle.

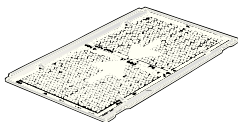

Fitting grease filters:

1. Clamp in the filter mats with the wire grid.

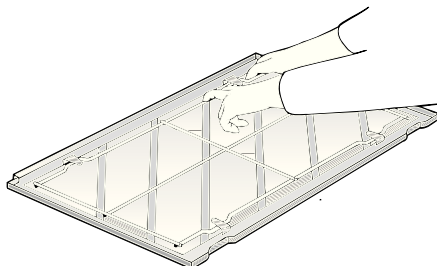

2. Position the filter screen against the housing and push upwards. Push in the lower edge over the lugs and lower the grid into place.

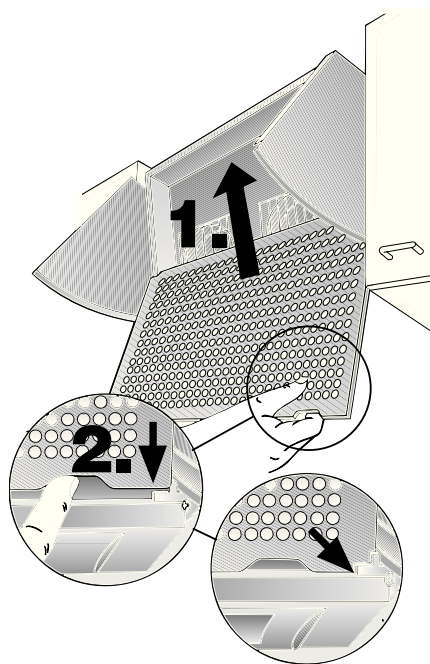

Check that the filter screen is securely located behind the retaining brackets on both sides.

Filters and maintenance

Activated carbon filter:

For binding odours in recirculating air mode.

Fitting and removal:

1. Open door to the stop.

2. Push the filter screen up slightly, lift it towards you over the brackets and take it out downwards.

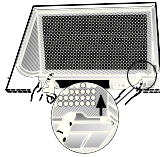

3. Insert the screw through the wing nut and bushing and screw into the housing (only necessary upon initial fitting). The screw and wing nut are included with activated carbon filter.

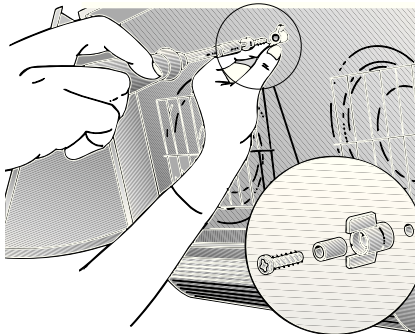

4. Using a screwdriver or similar, press the two lugs in the housing through to the back (only necessary upon initial fitting).

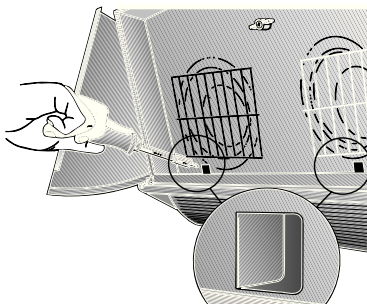

5. Insert activated carbon filter in the lower left corner of the housing. Shift it until both hooks slot into the holes and then secure in place with the wing nut.

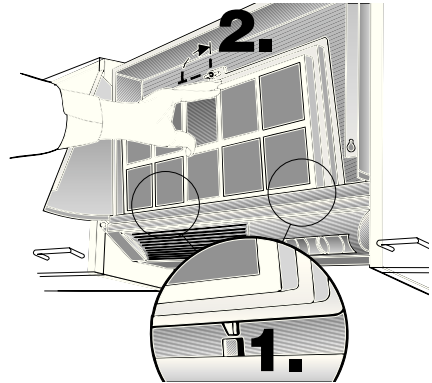

6. Position the filter screen against the housing and push upwards. Push in the lower edge over the brackets and lower the screen into place.

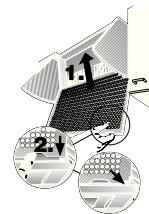

Check that the filter screen is securely located behind the retaining brackets on both sides.

Removal is in the reverse sequence.

Replacing the activated carbon filter:

- During normal operation (daily 1 to 2 hours) the activated carbon filter must be replaced approximately 1x year.
- The activated carbon filter can be purchased FROM YOUR DEALER (see Optional accessories).

Only use original filters.

- These ensure optimum function.

Disposal of the old activated carbon filter:

- Activated carbon filters do not contain any harmful substances. They can be disposed of as residual waste.

Cleaning and care

Isolate the extractor hood by pulling out the mains plug or switching off the fuse.

- When cleaning the grease filters, remove grease deposits from accessible parts of the housing. This prevents the risk of fire and ensures that the extractor hood continues operating at maximum efficiency.
- Clean the extractor hood with a hot soap solution or a mild window cleaner.
- Do not scrape off dried-on dirt but wipe off with a damp cloth.
- Do not use scouring agents or abrasive sponges.
- Note:** Do not use alcohol (spirit) on plastic surfaces, as dull marks may appear.

Caution: Ensure that the kitchen is adequately ventilated. Avoid naked flames!

⚠ Clean the operating buttons with a mild soapy solution and a soft, damp cloth only. Do not use stainless-steel cleaner to clean the operating buttons.

Aluminium and plastic surfaces:

- Use a soft, non-linting window cloth or micro-fibre cloth.
- Do not use dry cloths.
- Use a mild window cleaning agent.
- Do not use aggressive, acidic or caustic cleaners.
- Do not use abrasive agents.

Changing the bulbs

1. Switch off the extractor hood and deenergize by pulling out the mains plug or switching off the fuse.
2. Press the edges of the lamp cover together where indicated and lift it out towards you.

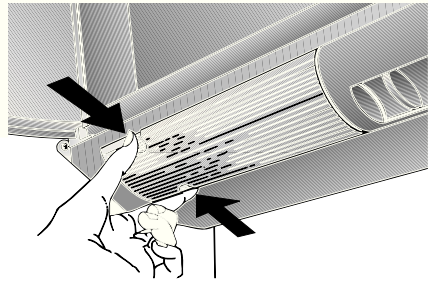

3. Replace the bulb (standard filament bulb, max 40 W, E14 bulb holder).
4. Refit lamp cover.
5. Reinsert mains plug or switch on the fuse.

Faults

If you should have any questions or there are any faults, call customer service (see list of customer service units).

Please give the following details when you call:

Product no. (E-Nr.)

Serial no. (FD)

Enter these numbers in the spaces above. You will find the numbers on the rating plate inside the extractor hood after removing the filter screen.

Important information

⚠ Old appliances are not worthless rubbish. Valuable raw materials can be reclaimed by recycling old appliances. Before disposing of your old appliance, render it unusable.

⚠ You received your new appliance in a protective shipping carton. All packaging materials are environmentally friendly and recyclable. Please contribute to a better environment by disposing of packaging materials in an environmentally-friendly manner.

Please ask your dealer or inquire at your local authority about current means of disposal.

⚠ The extractor hood can be used in exhaust air or circulating air mode.

⚠ Always mount the extractor hood over the centre of the hob.

⚠ The minimum distance between the hob and the lower edge of the extractor hood is **650 mm**.

⚠ The extractor hood must not be installed over a solid fuel cooker – a potential fire hazard (e.g. flying sparks) – unless the cooker features a closed, non-removable cover and all national regulations are observed.

⚠ The smaller the gap between the extractor hood and hotplates, the greater the likelihood that droplets will form on the underside of the extractor hood.

Additional information concerning gas cookers:

⚠ When installing gas hotplates, comply with the relevant national statutory regulations (e.g. in Germany: Technische Regeln Gasinstallation TRGI).

⚠ Always comply with the currently valid regulations and installation instructions supplied by the gas appliance manufacturer.

⚠ Only one side of the extractor hood may be installed next to a high-sided unit or high wall. Gap at least **50 mm**.

Before installation

Optimum efficiency of the extractor hood:

- Short, smooth exhaust pipe.
- As few bends as possible.
- Pipe diameter as large as possible (ideally 150 mm dia.) and wide pipe bends.

If long, rough exhaust-air pipes, many pipe bends or smaller pipe diameters are used, the air extraction rate will no longer be at an optimum level and there will be an increase in noise.

Round pipes

Short exhaust air pipe:

inside diameter **min. 120 mm**,

Longer exhaust air pipe:

inside diameter **min. 150 mm**.

- Flat ducts** must have an **inside cross-section equivalent** to that of the round pipes.

There should be no sharp bends.

ø 120 mm dia. approx. 113 cm²

ø 150 mm dia. approx. 177 cm²

- If pipe diameters differ, insert sealing strip.
- Ensure that there is an adequate air supply for exhaust air mode.

Before installation

Exhaust-air mode

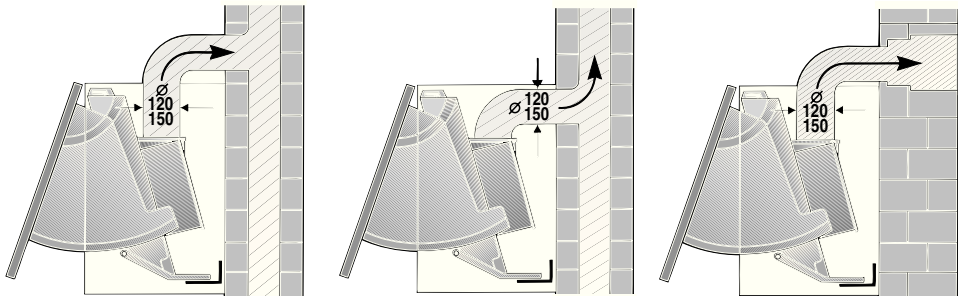

The exhaust air is discharged upwards through a ventilation shaft or directly through the outside wall into the open.

Exhaust air must not be discharged via a smoke or exhaust gas flue which is already in use or via a shaft which is used for ventilating rooms in which fireplaces are located.

Discharge exhaust air in accordance with official and statutory regulations (e.g. national building regulations).

Discharge of air into smoke or exhaust air flues which are not in use requires the consent of a heating engineer.

If the extractor hood is operated in exhaust-air mode at the same time as a flue-type heater (e.g. gas, oil or solid-fuel heater, instantaneous water heater, boiler), **ensure that there is an adequate air supply** which the heater requires for combustion.

Safe operation is possible provided that the partial vacuum in the room in which the heater is installed does not exceed 4 Pa (0.04 mbar).

This can be achieved if the combustion air is able to flow through non-lockable openings, e.g. in doors, windows and in conjunction with an air supply/air-intake wall box or by other technical procedures such as reciprocal interlocking.

If the air intake is inadequate, there is a risk of poisoning from combustion gases, which are drawn back into the room.

An air-intake/exhaust-air wall box by itself is no guarantee that the limiting value will not be exceeded.

Note: When assessing the overall requirement, the combined ventilation system for the entire household must be taken into consideration. This rule does not apply to the use of cooking appliances, such as hobs and gas cookers.

The extractor hood can be used without restriction in circulating air mode – with an activated carbon filter.

⚠ For exhaust air mode always cut out the protective grid in the air connector.

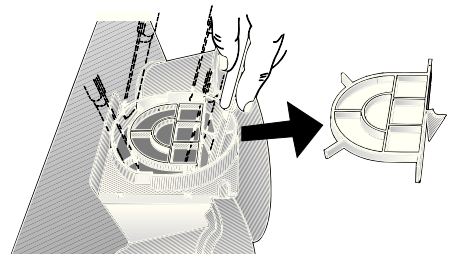

Before installation

With exhaust mode, a backwash valve should be installed unless it is already incorporated in the exhaust pipe or wall box. If a backwash valve is not included with your appliance, your dealer can supply you with one (see accessories).

Installation backwash valve:

Insert the backwash valve in the mounting openings on the air connector.

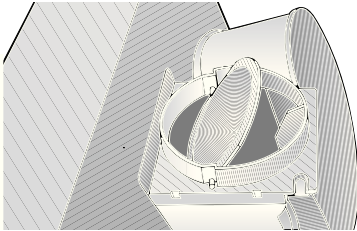

If the exhaust air is being routed through the outside wall, a telescopic wall box should be used.

Connecting to Ø100 mm exhaustair duct

Attach the reducing adapter (enclosed or available from specialist dealer) to the air outlet. Attach the exhaust-air duct to the adapter.

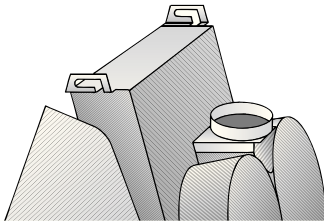

Connecting to Ø120 mm exhaustair duct

Attach the exhaust-air duct directly to the air outlet.

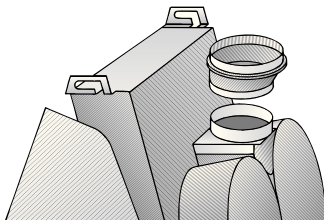

Connecting to Ø150 mm exhaustair duct

Attach the enlarging adapter (enclosed or available from specialist dealer) to the air outlet. Attach the exhaust-air duct to the adapter.

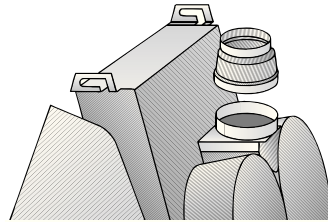

If a backflow flap has been installed, check that it functions properly.

Circulating-air mode

With activated carbon filter if exhaust-air mode is not possible.

The air purified by an additional activated carbon filter is returned to the room.

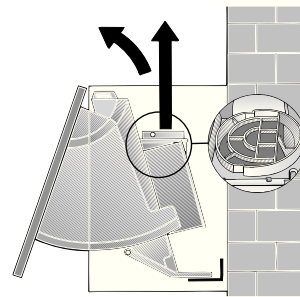

After installing the extractor hood, insert the activated carbon filter.

For installing see Filters and maintenance.

If the extractor hood is installed beneath a cabinet, ensure that there is an adequate air outlet (min. 177 cm²).

⚠ The extractor comes as standard equipped with a protective grid in the air connector. If this is has been removed (in the case of exhaust air operation), the air connector must be supplemented by a reducer piece with protective grid (see section on special accessories).

Electrical connection

WARNING:
THIS APPLIANCE MUST BE EARTHED

IMPORTANT: Fitting a Different Plug:

The wires in the power cord are colour-coded as follows:

Green and Yellow	– Earth
Blue	– Neutral
Brown	– Live

If you fit your own plug, the colours of these wires may not correspond with the identifying marks on the plug terminals.

Proceed as follows:

1. Connect the green and yellow (Earth) wire to the terminal in the plug marked 'E' or with the symbol (), or coloured green or green and yellow.
2. Connect the blue (Neutral) wire to the terminal in the plug marked 'N' or coloured black.
3. Connect the brown (Live) wire to the terminal marked 'L', or coloured red.

The extractor hood may be connected to a correctly installed earthed socket only. Attach the earthed socket near the extractor hood in an accessible position.

- The earthed socket should be connected via its own power circuit.

⚠ If appliances do not feature the OFF delay function, the indicator may start flashing when the extractor hood has been switched off for several hours via a separate switch, even though the grease filters are not yet saturated.

(See Filters and maintenance).

Electrical specifications:

These can be found on the rating plate inside the appliance following removal of the filter frames.

⚠ Before carrying out repairs, always isolate the appliance.

Length of the connection cable: 1.30 m.

If permanent connection is required:

The extractor hood may only be connected by an electrician registered with the local electricity board.

A disconnecting device must be provided on the installation side. Switches with a contact opening of more than 3 mm and all-pole disconnection are regarded as disconnecting devices. These include LS switches and contactors.

⚠ If the connecting cable for this appliance is damaged, the cable must be replaced by the manufacturer or his customer service or a similarly qualified person in order to prevent serious injury to the user.

This extractor hood complies with EU regulations on interference suppression.

Installation

Please note: A wall hanging set can be obtained from your dealer (see section on special accessories) for fastening the hood (e.g. at the end of the row of kitchen units).

The extractor hood is designed for installation between two wall cabinets.

1. Remove grease filter
(see Filters and maintenance)
2. Using the enclosed template mark the positions of the screws on the side panels of the neighbouring cabinets.

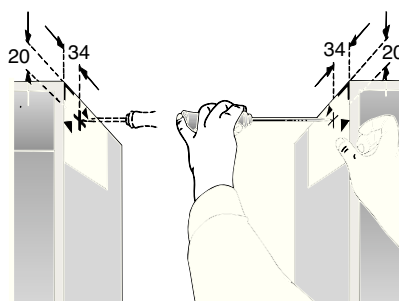

Installation

The extractor hood can also be installed slightly lower, depending on the height of the wall cupboards. Position the template correspondingly lower.

Observe the minimum distance from hob to extractor hood of **650 mm** (the **fixing screws** must be fitted **at least 1040 mm above the hob**).

3. Predrill (with bradawl or 2 mm bit) and screw in the screws to 5 mm.

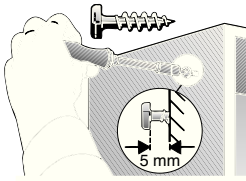

4. Suspend the extractor hood on the two screws between the wall cabinets.

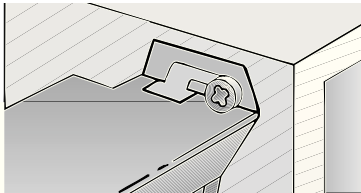

5. The two door carriers of the extractor flap must be pushed into the appliance to be stops.

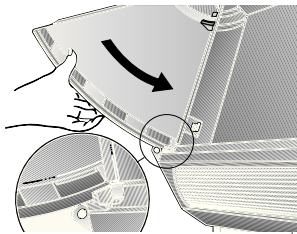

6. Align the extractor hood with the leading edge of the side cabinets.

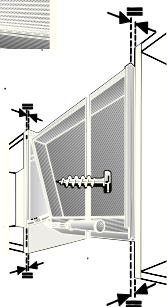

Important: If the door of the unit is at a distance from the body of the unit (e.g. due to rubber stops), the extractor hood must be drawn forward by the same distance.

7. Mark the position of the lower fixing screws, predrill and fasten the screws.
8. All four fixing screws must be firmly tightened.
9. Connect pipes.
10. Connect electricity.

Mounting the door:

Door thickness: min. 16 mm
 Door height: 380 to 700 mm
 Door weight: 7 kg (max.)

In order to match the wall cabinets on either side, the door can project at the top and bottom.

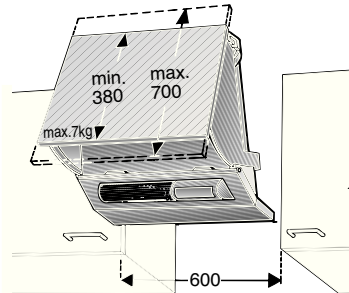

1. Remove the two door carriers to the right and left, by pulling both the red plastic catches inwards and removing the door carrier out towards you.

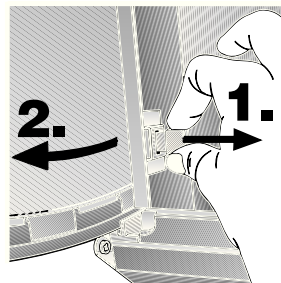

Installation

2. Mark the fixing points on the door. For dimensions of vertical screw fixings, see:

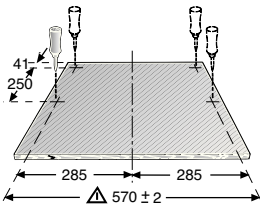

If the top edge of the door is not flush with the top edge of the cabinet, amend the dimensions accordingly.

If the tops of the cabinets are not installed flush with each other, the door must be mounted correspondingly higher.

The screw locations on the door can be marked directly on the door in situ. If you are doing this, leave the door carriers in the appliance. Position the door, align it and mark the back.

Keep precisely to the dimension 570 ± 2 .

3. Screw the door carriers to the door, making sure your left-right orientation is correct.

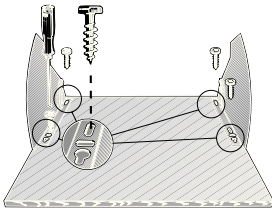

4. Insert the complete door into the extractor hood

Check that the door meets the stops on both sides when pulled out. This means that it is safely locked in place.

⚠ The red plastic catches can only be released if the door is not swung out to the stop.

5. The two screws to the right and left inside the housing can be used to adjust door gliding according to the weight of the door.

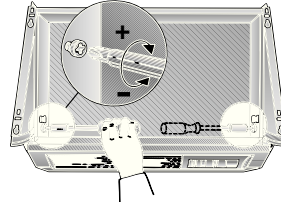

Turning the screws clockwise will make the door more difficult to move.

Mounting wall covering rail:

The gap between the hood and the rear wall can be dressed with the enclosed covering rail.

Screw-fasten the covering rail to the underside of the extractor hood.

Refit the grease filter.

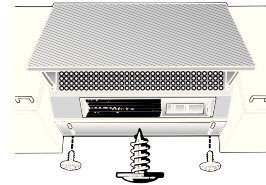

If the unit door has to be removed:

Pull the red plastic catches in the housing on both sides inwards to release the door, which can then be pulled out towards you.

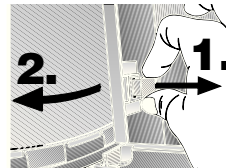

Weight in kg

Appliance version	Exhaust air	Recirculating air
single motor	6,5	7,8
dual motor	8,0	9,3

We reserve the right to construction changes within the context of technical development.

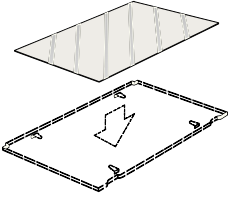
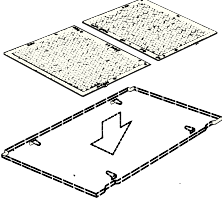
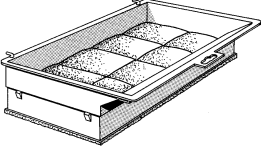
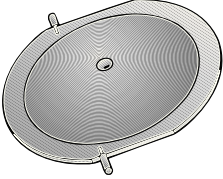
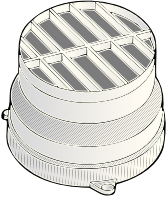
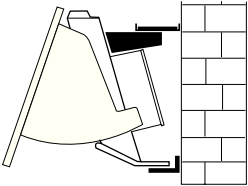
	<p>DHZ2100</p>
	<p>DHZ6201</p>
	<p>DSZ11AF</p>
	<p>086244</p>
	<p>088208</p>
	<p>DHZ6501</p>