

Contents

1	Instructions	42
1.1	General safety instructions	42
1.2	Identification plate	43
1.3	Manufacturer liability	43
1.4	Appliance purpose	43
1.5	Disposal	43
1.6	This user manual	44
1.7	How to read the user manual	44
2	Description	45
2.1	General Description	45
2.2	Cooking hob	46
2.3	Control panel	47
2.4	Other parts	48
2.5	Available accessories	48
3	Use	50
3.1	Instructions	50
3.2	First use	51
3.3	Using the accessories	51
3.4	Using the hob	52
3.5	Using the storage compartment	57
3.6	Using the ovens	57
3.7	Cooking advice	60
3.8	Programmer clock	61
4	Cleaning and maintenance	66
4.1	Instructions	66
4.2	Cleaning the appliance	66
4.3	Removing the door of the auxiliary oven	67
4.4	Cleaning the door glazing	68
4.5	Removing the internal glass panes	68
4.6	Cleaning the inside of the oven	70
4.7	Vapor Clean: assisted oven cleaning	71
4.8	Extraordinary maintenance	73
5	Installation	74
5.1	Electrical connection	74
5.2	Positioning	75

We advise you to read this manual carefully, which contains all the instructions for maintaining the appliance's aesthetic and functional qualities.

For further information on the product: www.smeg.com



1 Instructions

1.1 General safety instructions

Risk of personal injury

- During use the appliance and its accessible parts become very hot.
- Never touch the heating elements during use.
- Keep children under eight years of age at a safe distance if they are not constantly supervised.
- Children must never play with the appliance.
- This appliance may be used by children aged at least 8 and by people of reduced physical and mental capacity, or lacking in experience in the use of electrical appliances, provided that they are supervised or instructed by adults who are responsible for their safety.
- Never rest metallic objects such as knives, forks, spoons and lids on the appliance during use.
- Switch off the appliance immediately after use.
- Never try to put out a fire or flames with water: Turn off the appliance and smother the flames with a fire blanket or other appropriate cover.
- The appliance must never be cleaned by unsupervised children.
- Have qualified personnel carry out installation and assistance interventions according to the standards in force.
- Do not modify this appliance.
- Do not insert pointed metal

objects (cutlery or utensils) into the slots in the appliance.

- Do not try to repair the appliance yourself or without the intervention of a qualified technician.
- If the power supply cable is damaged, contact technical support immediately and they will replace it.
- Do not open the storage compartment (where present) when the oven is on and still hot.
- The items inside the storage compartment could be very hot after using the oven.

Risk of damaging the appliance

- Do not use abrasive or corrosive detergents on glass parts (e.g. powder products, stain removers and metallic sponges).
- Racks and trays have to be inserted into the side guides until they come to a complete stop. The mechanical safety locks that prevent the rack from being taken out accidentally have to face downwards and towards the oven back.
- Use wooden or plastic utensils.
- Do not seat on the appliance.
- Do not use steam jets to clean the appliance.



- Do not obstruct ventilation openings and heat dispersal slots.
- Never leave the appliance unattended during cooking operations where fats or oils could be released.
- Never leave objects on the cooking surface.
- Do not use the appliance to heat rooms for any reason.
- Remove any food residues or large spills from previous cooking operations from the inside of the oven.

For this appliance

- Before replacing the bulb, switch off the power supply to the appliance.
- Do not rest any weight or sit on the open door of the appliance.
- Take care that no objects are stuck in the doors.
- If cracks or fissures form, or if the glass ceramic cooking surface breaks, turn off the appliance immediately. Disconnect the power supply and call Technical Support.
- People who have pacemakers or other similar devices fitted must make sure that the operation of these devices is not jeopardised by the inductive field, whose frequency range is between 20 and 50 kHz.

- In conformity with the provisions regarding electromagnetic compatibility, the electromagnetic induction cooking hob comes under group 2 and class B (EN 55011).

1.2 Identification plate

- The identification plate bears the technical data, serial number and brand name of the appliance. Do not remove the identification plate for any reason.

1.3 Manufacturer liability

The manufacturer declines all liability for damage to persons or property caused by:

- Use of the appliance other than as envisaged;
- Non-observance of the user manual provisions;
- Tampering with any part of the appliance;
- Use of non-original spare parts.

1.4 Appliance purpose

- This appliance is intended for cooking food in the home environment. Every other use is considered improper.
- The appliance is not designed to operate with external timers or with remote-control systems.

1.5 Disposal



This appliance must be disposed of separately from other waste (Directives 2002/95/EC, 2002/96/EC, 2003/108/EC). The appliance does not contain substances in quantities sufficient to be considered hazardous to health and the environment, in accordance with current European directives.

To dispose of the appliance:



Instructions

- Remove the doors and leave the accessories (racks and trays) in their usual working positions, so that children cannot get stuck in the oven compartment.



Power voltage Danger of electrocution

- Disconnect the main power supply.
 - Unplug the appliance.
- Cut the power supply cable and remove it along with the plug.
 - Deliver the appliance to the appropriate recycling centre for electrical and electronic equipment waste, or return it to the retailer when purchasing an equivalent product, on a one for one basis.

Our appliances are packed in non-polluting and recyclable materials.

- Deliver the packing materials to the appropriate recycling centre.



Plastic packaging Danger of suffocation

- Do not leave the packaging or any part of it unattended.
- Do not let children play with the packaging plastic bags.

1.6 This user manual

This user manual is an integral part of the appliance and must therefore be kept in its entirety and within the user's reach for the whole working life of the appliance. Read this user manual carefully before using the appliance.

1.7 How to read the user manual

This user manual uses the following reading conventions:



Instructions

General information on this user manual, on safety and final disposal.



Description

Description of the appliance and its accessories.



Use

Information on the use of the appliance and its accessories, cooking advice.



Cleaning and maintenance

Information for proper cleaning and maintenance of the appliance.



Installation

Information for the qualified technician: Installation, operation and inspection.



Safety instructions



Information



Advice

1. Use instruction sequence.

- Standalone use instruction.



2 Description

2.1 General Description

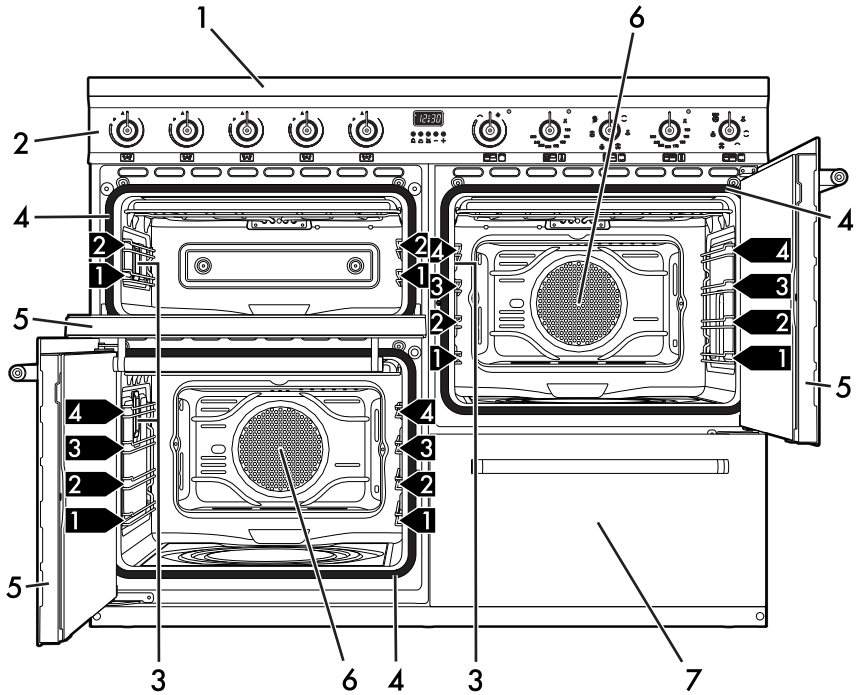

1 Cooking hob

2 Control panel

3 Oven light

4 Seal

5 Door

6 Fan

7 Storage compartment

1,2,3,... Rack/tray support frame shelf



Description

2.2 Cooking hob

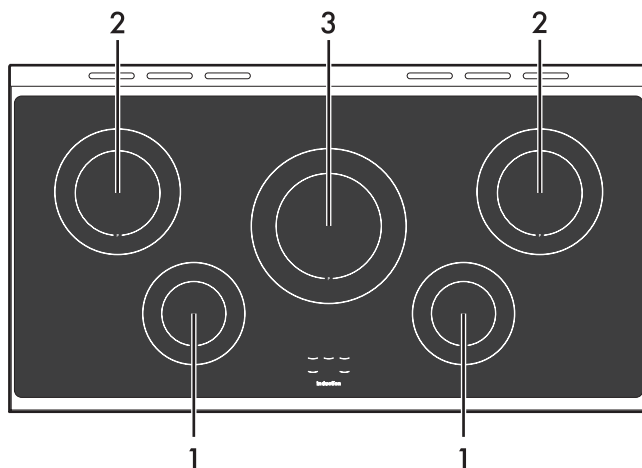

Zone	Outer diameter (mm)	Max. power absorbed (W)*	Power absorbed in Booster function (W)*
1	180	1300	1400
2	210	2300	3000
3	270	2300	3000

* power levels are indicative and can vary according to the pan used or the settings made.

Advantages of induction cooking



The hob is equipped with an induction generator for each cooking zone. Each generator located under the glass ceramic cooking surface creates an electromagnetic field which induces a thermal current in the base of the pan. This means the heat is no longer transmitted from the hob to the pan but created directly inside the pan by the inductive current.

- Energy saving thanks to the direct transmission of energy to the pan (suitable magnetisable cookware is required) compared to traditional electric cooking.
- Improved safety as the energy is only transmitted to the pan placed on the hob.
- High level of energy transmitted from the induction cooking zone to the base of the pan.
- Rapid heating speed.
- Reduced danger of burns as the cooking surface is only heated under the base of the pan; foods which overflow do not stick.



2.3 Control panel

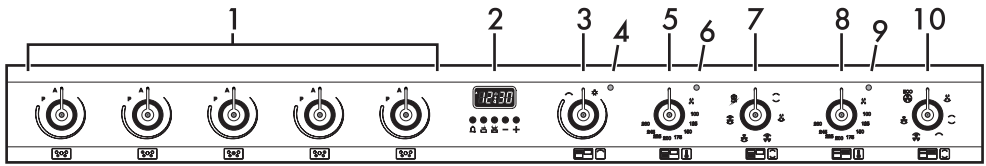

Cooking zone control knobs (1)

Useful for controlling the cooking zones of the induction hob.

Turn the knob clockwise to adjust the operating power of the hot plate from a minimum of 1 to a maximum of 9.

The working power is indicated on the display on the hob.

Programmer clock (2)

Useful for displaying the current time, setting programmed cooking operations and programming the minute minder timer.

Auxiliary oven variable grill knob (3)

It turns on the light inside the oven or starts the grill heating element to a temperature ranging from a minimum of 50°C to a maximum of 245°C.

Auxiliary oven variable grill indicator light (4)

The indicator light comes on to indicate that the auxiliary oven is heating up. It turns off as soon as it reaches the set temperature. It flashes regularly to indicate that the temperature set inside the oven is kept constant.

Lower multifunction oven temperature knob (5)

This knob allows you to select the cooking temperature.

Turn the knob clockwise to the required value, between the minimum and maximum setting.

Lower multifunction oven indicator light (6)

The indicator light comes on to indicate that the oven is heating up. It turns off as soon as it reaches the set temperature. It flashes regularly to indicate that the temperature set inside the oven is kept constant.

Lower multifunction oven function knob (7)

The oven's various functions are suitable for different cooking methods. After selecting the required function, set the cooking temperature using the temperature knob.

Upper multifunction oven temperature knob (8)

This knob allows you to select the cooking temperature and the Vapor Clean temperature.

Turn the knob clockwise to the required value, between the minimum and maximum setting.



Description

Upper multifunction oven indicator light (9)

The indicator light comes on to indicate that the oven is heating up. It turns off as soon as it reaches the set temperature. It flashes regularly to indicate that the temperature set inside the oven is kept constant.

Upper multifunction oven function knob (10)

The oven's various functions are suitable for different cooking methods. After selecting the required function, set the cooking temperature using the temperature knob.

2.4 Other parts

Shelves

The appliance features shelves for positioning trays and racks at different heights. The insertion heights are indicated from the bottom upwards (see 2.1 General Description).

Cooling fan

The fan cools the ovens and comes into operation during cooking.

The fan causes a steady outflow of air that exits from the rear of the appliance and which may continue for a brief period of time even after the appliance has been turned off.

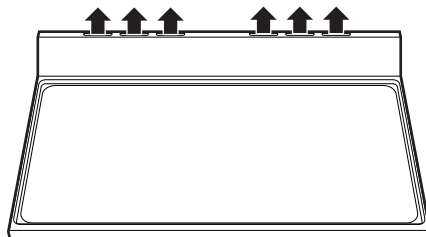

Interior lighting

The internal light of the ovens comes on when any function is selected.

2.5 Available accessories



Some models are not provided with all accessories.

Rack

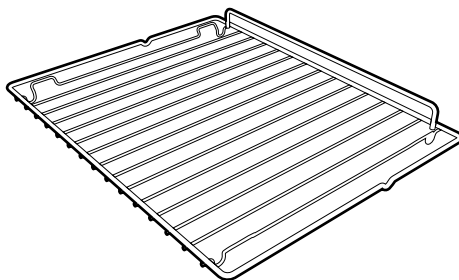

Useful for supporting containers with food during cooking.



Tray rack

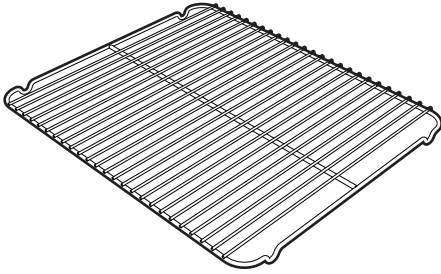

To be placed over the top of the oven tray; for cooking foods which may drip.

Oven tray

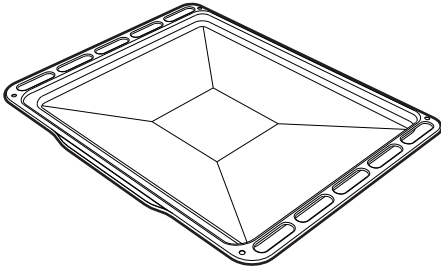

Useful for collecting fat from foods placed on the rack above.

Deep tray

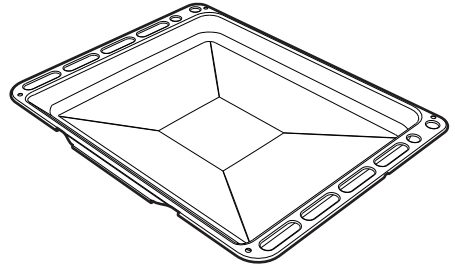

Useful for collecting fat from foods placed on the rack above and for cooking pies, pizzas and baked desserts.

Scraper

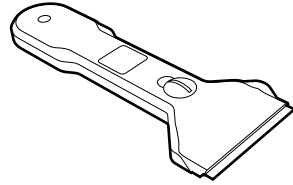

Useful for cleaning the hob.



The accessories intended to come into contact with food are made of materials that comply with the provisions of current legislation.



Supplied and optional accessories can be requested to Authorised Assistance Centres. Use only original accessories supplied by the manufacturer.



Use

3 Use

3.1 Instructions



High temperature inside the oven during use

Danger of burns

- Keep the oven door closed during cooking.
- Protect your hands wearing heat resistant gloves when moving food inside the oven.
- Do not touch the heating elements inside the oven.
- Do not pour water directly onto very hot trays.
- Do not allow children younger than 8 years old to come near the appliance when in operation.
- If you need to move food or at the end of cooking, open the door 5 cm for a few seconds, let the steam come out, then open it fully.



High temperature inside the storage compartment

Danger of burns

- Do not open the storage compartment when the oven is on and still hot.
- The items inside the storage compartment could be very hot after using the oven.



Improper use

Danger of burns

- Oils and fats could catch fire if overheated. Be very careful.
- Never place metal objects, such as dishes or cutlery, on the induction hob surface as they may overheat.



High temperature inside the oven during use

Danger of fire or explosion

- Do not spray any spray products near the oven.
- Do not use or leave flammable materials near the oven or the storage compartment.
- Do not use plastic kitchenware or containers when cooking food.
- Do not put sealed tins or containers in the oven.
- Do not leave the oven unattended during cooking operations where fats or oils could be released.
- Remove all trays and racks which are not required during cooking.



Improper use

Risk of damage to surfaces

- Do not cover the bottom of the oven cavity with aluminium or tin foil sheets.
- If you wish to use greaseproof paper, place it so that it will not interfere with the hot air circulation inside the oven.
- Do not place pans or trays directly on the bottom of the oven cavity.
- Do not use the open door to rest pans or trays on the internal glass pane.
- Do not pour water directly onto very hot trays.
- Cooking vessels or griddle plates should be placed inside the perimeter of the hob.
- All pans must have smooth, flat bottoms.
- If any liquid does boil over or spill, remove the excess from the hob.
- Avoid hard, solid objects falling on the surface of the hob.
- In case you notice cracks or fissures, turn off the appliance immediately, disconnect the power supply and contact the Assistance Centre.
- Do not use the hob as a support surface.

3.2 First use

1. Remove any protective film from the outside or inside of the appliance, including accessories.
2. Remove any labels (apart from the technical data plate) from the accessories and from the cooking compartments.
3. Remove and wash all the appliance accessories (see 4 Cleaning and maintenance).
4. Heat the empty ovens at the maximum temperature to burn off any residues left by the manufacturing process.

3.3 Using the accessories

Tray rack

The tray rack has to be inserted into the tray. In this way fat can be collected separately from the food which is being cooked.

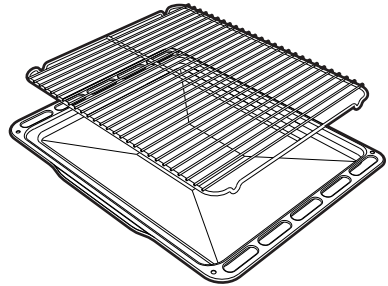



Racks and trays

Racks and trays have to be inserted into the side guides until they come to a complete stop.

- The mechanical safety locks that prevent the rack from being taken out accidentally have to face downwards and towards the oven back.

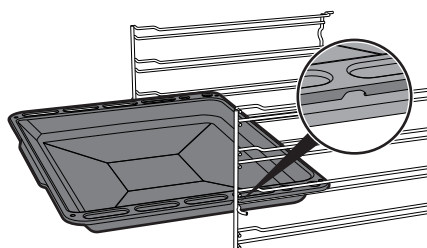
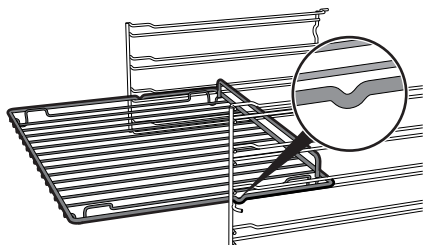

3.4 Using the hob

i On first connection to the electrical mains, an automatic check will be carried out that will switch on all indicator lights for a few seconds.

i After use, turn off the cooking zones used by returning the appropriate knob to the **O** position. Never rely solely on the cookware detector.

All the appliance's control and monitoring devices are located together on the front panel. The relevant cooking zone is indicated next to each knob.

Just turn the knob clockwise to the required power setting.



Gently insert racks and trays into the oven until they come to a stop.



Clean the trays before using them for the first time to remove any residues left by the manufacturing process.



Cookware suitable for use in induction cooking

Cookware used on the induction cooking surface must be made of metal, with magnetic properties and a sufficiently large base.

Suitable cookware:

- Enamelled steel cookware with thick bases.
- Cast iron cookware with an enamelled base.
- Cookware in multilayer stainless steel, ferritic stainless steel and aluminium with a special base.

Unsuitable cookware:

- Copper, stainless steel, aluminium, fireproof glass, wood, ceramic and terracotta cookware.

To see whether the pan is suitable, bring a magnet close to the bottom: if it is attracted, the pan is suitable for induction cooking. If you do not have a magnet, you can put a small amount of water in the pan, place it on a cooking zone and start the cooking zone. If the symbol  appears on the display, it means the pan is not suitable.

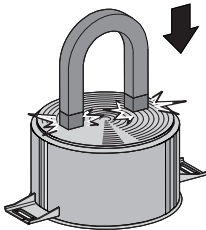

Use only cookware with a perfectly flat bottom which is suitable for induction hobs. Using cookware with an irregular bottom could jeopardise the efficiency of the heating system and prevent cookware from being detected on the cooking zone.

Cookware recognition

When there is no saucepan on a cooking zone or if the saucepan is too small, no energy will be transmitted and the symbol  will appear on the display.

If there is a suitable saucepan on the cooking zone, the recognition system notices it and turns on the hob to the power level set using the knob. Energy transmission is also interrupted when the saucepan is removed from the cooking zone (the symbol  will be shown on the display).

If the cookware recognition function is activated in spite of the saucepan or frying pan on the cooking zone being smaller than the zone itself, only the necessary energy will be transmitted.

Cookware recognition limits: The minimum diameter of the saucepan base is indicated by a circle inside the cooking zone. Pans with smaller diameters risk not being detected and therefore not activating the inductor.



Limiting the cooking duration

The hob has an automatic device which limits the duration of use.

If the cooking zone settings are not changed, the maximum duration of operation for each zone depends on the power level selected.

When the device for limiting the duration of use is activated, the cooking zone turns off, a short alert sounds and, if the zone is hot, the **H** symbol appears on the display.

Set power level	Maximum cooking duration in hours
1	8
2	6
3 - 4	5
5	4
6 - 7 - 8 - 9	1 ½

Protection from overheating

If the hob is used on full power for a long period, the electronics will have trouble cooling down if the room temperature is high.

To avoid excessively high temperatures forming in the electronics, the power to the cooking zone is reduced automatically.

Advice on energy-saving

- The diameter of the base of the pan must correspond to the diameter of the cooking zone.



- When buying a pan, check whether the diameter indicated is that of the base or the top of the pan, as the top is almost always larger than the base.
- When preparing dishes with long cooking times, you can save time and energy by using a pressure cooker, which also makes it possible to preserve the vitamins in the food.
- Make sure that the pressure cooker contains enough liquid as, if there is not enough and it overheats, this may cause damage to both the pressure cooker and the cooking zone.
- If possible, always cover pans with a suitable lid.
- Choose a pan suitable for the quantity of food to be cooked. A large, half-empty pan leads to a waste of energy.



Under certain circumstances, if the hob and the oven are being used at the same time, the maximum power limit that can be used by the electrical system might be exceeded.



Power levels

The power in the cooking zone can be adjusted to various levels. The table shows the levels suitable for various types of cooking.

Power level	Suitable for:
0	OFF setting
1 - 2	Cooking small amounts of food (minimum power)
3 - 4	Cooking
5 - 6	Cooking large quantities of food, roasting larger portions
7 - 8	Roasting, slow frying with flour
9	Roasting
p *	Roasting / browning, cooking (maximum power)

* see booster function

Residual heat



Improper use Danger of burns

- Supervise children carefully as they cannot readily see the residual heat indicator. The cooking zones remain hot for a certain period of time even after they have been turned off. Make sure that children never touch the hob.

If the cooking zone is still hot after being switched off, the symbol **H** will be displayed on the display. The symbol clears once the temperature drops below 60°C.

Heating accelerator



Each cooking zone is equipped with a heating accelerator that allows the maximum power to be delivered for a time that is proportional to the selected power.

This function allows the selected power to be achieved in the shortest amount of time.

- Turn the knob anti-clockwise to the **A** position and release it. The display shows the symbol **A**.
- Select the required heating power (**1 - 8**) within 3 seconds. The selected power and symbol **A** will flash alternately on the display.

The power level can be increased at any moment. The "maximum power" period will automatically be modified.

Once the acceleration period is over the power level will remain the same as the one previously selected.



If the power is reduced, turning the knob anti-clockwise, the heating accelerator will automatically be disabled.



Booster function

i The booster function allows you to activate the cooking zone at maximum power as long as 5 minutes. It can be used to bring a large quantity of water to a boil rapidly or to broil meat.

- Turn the knob clockwise to the **P** position for two seconds and then release. The display shows the symbol **P**. After 5 minutes the booster function will automatically be disabled and cooking will continue at power level **9** (on zones **2** and **3** only).

i The booster function has priority over the heating accelerator function.

Power control

The hob is fitted with a power control module that optimises/limits consumption. If the overall set power level exceeds the maximum limit permitted, the electronic circuit board will automatically manage the power supplied by the cooking zones. The module tries to maintain the maximum deliverable power levels. Levels set by the automatic control will appear on the display.

The flashing of a power level indicates that it will be automatically limited to a new level selected by the power control module.

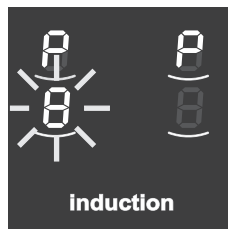

i Priority is given to the last zone set.

Control lock

i The control lock is a device that protects the appliance from accidental or inappropriate use.

1. With all cooking zones off, simultaneously turn the two cooking zone control knobs to the left (position **A**).
2. Keep them turned until the symbols **L** appear on the display.
3. Release the knobs.

In order to remove the control lock repeat the same operations described previously.

i If the knobs have been kept turned to the **A** position for more than 30 seconds a fault message appears on the display. **P**



After a prolonged period of interruption to the power supply, the control lock will be deactivated. If this is the case, turn it back on as described above.

Error codes

If the display shows one of the following error codes **E**, **E**, contact Technical Assistance.

3.5 Using the storage compartment

The storage compartment is at the bottom right of the cooker. It can be used to store cookware or metallic objects necessary when using the appliance.

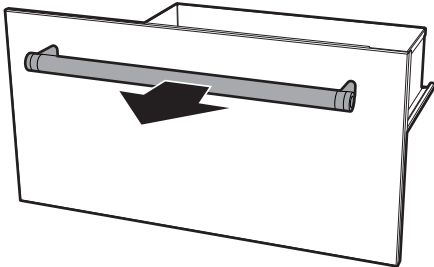

3.6 Using the ovens

Switching on multifunction ovens



To switch on multifunction ovens:

1. Select the cooking function using the function knob.
2. Select the temperature using the temperature knob.

Opening and closing the doors of multifunction ovens

Multifunction ovens are equipped with a swing door. To open, pull the door handle towards you. To close, push the doors until you hear a mechanical "click".



The maximum extent the doors of the multifunction ovens can be opened to is 110°.

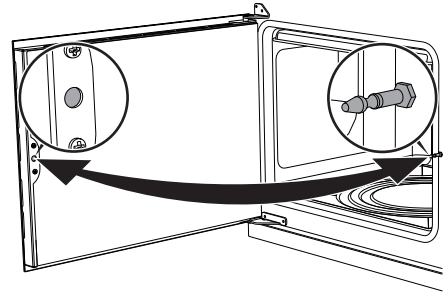

Multifunction oven doors do not block laterally when opening and they might close. During use, pay attention not to come into contact with the internal glass pane to prevent burns.



Use



Over time the swing doors might get difficult to open and close. Grease the hinges.

Switching on the auxiliary oven



To switch on the auxiliary oven:

- Select the temperature using the variable grill knob. The temperature ranges indicatively from a minimum of 50°C and a maximum of 300°C.



Turning on the light inside the auxiliary oven



To turn on the light inside the auxiliary oven:

- Select the light bulb symbol with the variable grill knob.

Functions list



ECO

Depending on the function it is combined with, this ensures the greatest possible energy savings during cooking.



Static

As the heat comes from above and below at the same time, this system is particularly suitable for certain types of food. Traditional cooking, also known as static cooking, is suitable for cooking just one dish at a time. Perfect for all types of roasts, bread and cakes, and in any case, particularly suitable for fatty meats such as goose and duck.



Lower element

The heat coming just from the bottom allows you to complete the cooking of foods that require a higher bottom temperature, without affecting their browning. Perfect for cakes, pies, tarts and pizzas.



Fan with grill

The air produced by the fan softens the strong heatwave generated by the grill, grilling perfectly even very thick foods. Perfect for large cuts of meat (e.g. shin of pork).



Fan assisted

The operation of the fan, combined with traditional cooking, ensures consistent cooking even with complex recipes. Perfect for biscuits and cakes, even when simultaneously cooked on several levels. (For multiple-level cooking, we recommend using the 2nd and 4th shelves).



Fan + lower element

The combination of the fan with just the lower heating element allows cooking to be completed more rapidly. This system is recommended for sterilising or for finishing off the cooking of foods which are already well-cooked on the surface, but not inside, which therefore need a little more heat. Perfect for any type of food.

In pyrolytic models, the special defrost and proving functions are brought together under the same function.



Rapid defrost

Rapid defrost is helped by the activation of a fan to ensure uniform distribution of room temperature air inside the oven. Perfect for any type of food.



Grill

The heat coming from the grill element gives perfect grilling results above all for thin and medium thickness meat and, in combination with the rotisserie (where fitted), gives the food an even browning at the end of cooking. Perfect for sausages, spare ribs and bacon. This function enables large quantities of food, particularly meat, to be grilled evenly.



Fan with circulaire

The combination of the fan and the circulaire heating element (incorporated in the rear of the oven) allows you to cook different foods on several levels, as long as they need the same temperatures and same type of cooking. Hot air circulation ensures instant and even distribution of heat. It will be possible, for instance, to cook fish, vegetables and biscuits simultaneously (on different levels) without odours and flavours mingling.



3.7 Cooking advice

General advice

- Use a fan assisted function to achieve consistent cooking at several levels.
- It is not possible to shorten cooking times by increasing the temperature (the food could be overcooked on the outside and undercooked on the inside).

Advice for cooking meat

- Cooking times vary according to the thickness and quality of the food and to consumer taste.
- Use a meat thermometer when roasting meat, or simply press on the roast with a spoon. If it is hard, it is ready; If not, it needs another few minutes cooking.

Advice for cooking with the Grill and the Fan with grill

- Meat can be grilled even when it is put into the cold oven or into the preheated oven if you wish to change the effect of the cooking.
- With the Fan with grill function, we recommend that you preheat the oven before grilling.
- We recommend placing the food at the centre of the rack.
- With the Grill function, we recommend that you turn the temperature knob to the maximum value corresponding to the  symbol (where present) to optimise cooking.

- Foods should be seasoned before cooking. Foods should also be coated with oil or melted butter before cooking.
- Use the oven tray on the first bottom shelf to collect liquids produced by grilling.
- Grilling processes should never last more than 60 minutes using multifunction ovens, 30 minutes inside the auxiliary oven.

Advice for cooking desserts/pastries and biscuits

- Use dark metal moulds: They help to absorb the heat better.
- The temperature and the cooking time depend on the quality and consistency of the dough.
- To check whether the dessert is cooked right through: At the end of the cooking time, put a toothpick into the highest point of the dessert. If the dough does not stick to the toothpick, the dessert is cooked.
- If the dessert collapses when it comes out of the oven, on the next occasion reduce the set temperature by about 10°C, selecting a longer cooking time if necessary.
- While cooking desserts or vegetables, excessive condensation may form on the glass. In order to avoid this, open the door very carefully a couple of times while cooking.



Advice for defrosting and proving

- Place frozen foods without their packaging in a lidless container on the first shelf of the oven.
- Avoid overlapping the food.
- To defrost meat, use the rack placed on the second level and a tray on the first level. In this way, the liquid from the defrosting food drains away from the food.
- The most delicate parts can be covered with aluminium foil.
- For successful proving, a container of water should be placed in the bottom of the oven.

To save energy

- Stop cooking a few minutes before the time normally used. Cooking will continue for the remaining minutes with the heat which has accumulated inside the oven.
- Reduce any opening of the door to a minimum to avoid heat dispersal.
- Keep the inside of the appliance clean at all times.

3.8 Programmer clock

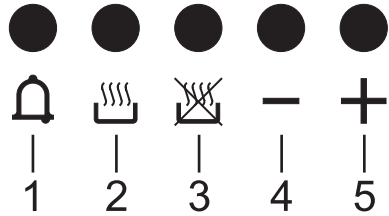

- 1 Minute minder timer key
- 2 Cooking duration key
- 3 End of cooking key
- 4 Value decrease key
- 5 Value increase key

i The programmer clock controls exclusively the right multifunction oven and has not any control on the other ovens.

Setting the time

On the first use, or after a power failure, the digits **A 0:00** will be flashing on the appliance's display.

1. Press the keys and at the same time. The dot between the hours and the minutes flashes.
2. The time can be set using or . Keep the key pressed in to increase or decrease rapidly.



Use

3. Press the key or wait 5 seconds. The dot between the hours and the minutes stops flashing.
4. The symbol on the display indicates that the appliance is ready to start cooking.

Timed cooking

i Timed cooking is the function which allows a cooking operation to be started and then ended after a specific length of time set by the user.

1. After selecting a cooking function and temperature, press the key . The display will show the digits and the symbol displayed between the hours and the minutes.
2. Use the or key to set the required minutes.
3. Wait approx. 5 seconds without pressing any key in order for the function to activate. The current time and the symbols and will appear on the display.
4. At the end of cooking the heating elements will be deactivated. On the display, symbol turns off, symbol flashes and the buzzer sounds.

5. To turn off the buzzer just press any key of the programmer clock.
6. Press the keys and at the same time to reset the programmer clock.



It is not possible to set a cooking time of more than 10 hours.



After the setting, to display the cooking time left press the key.



To reset the set program, press the keys and at the same time and switch off the oven manually.

Programmed cooking



i Programmed cooking is the function which allows a cooking operation to be started at a set time and then ended after a specific length of time set by the user.

1. Set the cooking time as described in the previous point "Timed cooking".
2. Press . The sum of the current time plus the pre-set cooking duration will appear on the display.



3. Use the or key to set the required minutes.
4. Wait approx. 5 seconds without pressing any key in order for the function to activate. The current time and the symbols and will appear on the display.
5. At the end of cooking the heating elements will be deactivated. On the display, symbol turns off, symbol flashes and the buzzer sounds.
6. To turn off the buzzer just press any key of the programmer clock.
7. Press the keys and at the same time to reset the programmer clock.



After the setting, to display the cooking time left press the key. To display the end of cooking time, press the key.

Minute minder timer



The minute minder timer does not stop the cooking operation but rather informs the user when the set time has run out.

The minute minder timer can be activated at any time.

1. Press . The display shows the digits and the indicator light flashing between the hours and the minutes.
2. Use the or key to set the required minutes.
3. Wait approx. 5 seconds without pressing any key to finish setting the minute minder. The current time and the symbols and appear on the display.



It is not possible to set a cooking time of more than 24 hours.





After the minute minder timer has been programmed, the display will go back to showing the current time; to display the remaining time, press .



Adjusting the buzzer volume

The buzzer volume can be set to 3 different levels. When the buzzer is in operation, press  to change the setting.

Deleting the set data

Press the keys  and  at the same time to reset the programs set.

Then switch off the oven manually if cooking is in progress.



Cooking information table

Food	Weight (Kg)	Function	Runner position from the	Temperature (°C)	Time (minutes)	
Lasagne	3 - 4	Static	1	220 - 230	45 - 50	
Pasta bake	3 - 4	Static	1	220 - 230	45 - 50	
Roast veal	2	Fan assisted	2	180 - 190	90 - 100	
Pork	2	Fan assisted	2	180 - 190	70 - 80	
Sausages	1.5	Fan with grill	4	260	15	
Roast beef	1	Fan assisted	2	200	40 - 45	
Roast rabbit	1.5	Circulaire	2	180 - 190	70 - 80	
Turkey breast	3	Fan assisted	2	180 - 190	110 - 120	
Roast pork neck	2 - 3	Fan assisted	2	180 - 190	170 - 180	
Roast chicken	1.2	Fan assisted	2	180 - 190	65 - 70	
					1 nd	2 nd
Pork chops	1.5	Fan with grill	4	260	15	5
Spare ribs	1.5	Fan with grill	4	260	10	10
Bacon	0.7	Grill	5	250 - 260	7	8
Pork fillet	1.5	Fan with grill	4	250 - 260	10	5
Beef fillet	1	Grill	5	250 - 260	10	7
Salmon trout	1.2	Fan assisted	2	150 - 160	35 - 40	
Monkfish	1.5	Fan assisted	2	160	60 - 65	
Turbot	1.5	Fan assisted	2	160	45 - 50	
Pizza	1	Fan assisted	2	260	8 - 9	
Bread	1	Circulaire	2	190 - 200	25 - 30	
Focaccia	1	Fan assisted	2	180 - 190	20 - 25	
Bundt cake	1	Circulaire	2	160	55 - 60	
Jam tart	1	Circulaire	2	160	35 - 40	
Ricotta cake	1	Circulaire	2	160 - 170	55 - 60	
Jam tarts	1	Circulaire	2	160	20 - 25	
Paradise cake	1.2	Circulaire	2	160	55 - 60	
Profiteroles	1.2	Circulaire	2	180	80 - 90	
Sponge cake	1	Circulaire	2	150 - 160	55 - 60	
Rice pudding	1	Circulaire	2	160	55 - 60	
Brioches	0.6	Circulaire	2	160	30 - 35	

The times indicated in the table do not include preheating times and are provided only as a guide.



4 Cleaning and maintenance

4.1 Instructions



Improper use

Risk of damage to surfaces

- Do not use steam jets to clean the appliance.
- Do not use cleaning products containing chlorine, ammonia or bleach on steel parts or parts with metallic finishes on the surface (e.g. anodizing, nickel- or chromium-plating).
- Do not use abrasive or corrosive detergents on glass parts (e.g. powder products, stain removers and metallic sponges).
- Do not use rough or abrasive materials or sharp metal scrapers.
- Do not wash the removable components such as the hob pan stands in a dishwasher.
- Do not spill sugar or sweet mixtures on the hob while cooking or place materials or substances which could melt on it (plastic or tin foil). If this happens, to avoid damage to the surface, turn off the heat immediately and clean the surface with the scraper provided while the cooking zone is still lukewarm.

4.2 Cleaning the appliance

To keep the surfaces in good condition, they should be cleaned regularly after use. Let them cool first.

Ordinary daily cleaning

Always use only specific products that do not contain abrasives or chlorine-based acids.

Pour the product onto a damp cloth and wipe the surface, rinse thoroughly and dry with a soft cloth or a microfibre cloth.

Food stains or residues

Do not use metallic sponges or sharp scrapers as they will damage the surfaces.

Use ordinary non-abrasive products with the aid of wooden or plastic utensils if necessary. Rinse thoroughly and dry with a soft cloth or a microfibre cloth.

Do not allow residues of sugary foods (such as jam) to set inside the oven. If left to set for too long, they might damage the enamel lining of the oven.

Cleaning the glass ceramic hob

Smudges from aluminium-based pans can be easily cleaned off with a cloth dampened in vinegar.

After cooking, remove any burnt residues with the scraper provided; rinse with water and dry thoroughly with a clean cloth.

Regular use of the scraper considerably reduces the need for chemical detergents for the daily cleaning of the hob.



Dirt which may have fallen on the hob while cleaning lettuce or potatoes can scratch the hob when moving pans.

Consequently, remove any dirt from the cooking surface immediately.

Changes in colour do not affect the operation and stability of the glass. These are not alterations to the material of the hob but just residues which have not been removed and have then carbonised.

Shiny surfaces can form due to the bases of pans, especially aluminium ones, rubbing on the surface, and due to the use of unsuitable detergents. They are difficult to remove using conventional cleaning products. It may be necessary to repeat the cleaning process several times. Use of corrosive detergents or rubbing of pan bases can wear away the decoration on the hob over time and contribute to the formation of stains.

Weekly cleaning

Clean and maintain the hob once a week using an ordinary glass ceramic cleaning product. Always follow the manufacturer's instructions. The silicon in these products creates a protective, water-repellent membrane which also resists dirt. All marks stay on the membrane and can therefore be removed easily. After cleaning, dry the surface with a clean cloth. Make sure that there is no detergent left on the cooking surface as it might undergo an aggressive reaction when heated up and could modify the structure of the cooking surface.

4.3 Removing the door of the auxiliary oven

For easier cleaning, the door can be removed and placed on a canvas.

To remove the door proceed as follows:

1. Open the door completely and insert two pins into the holes on the hinges indicated in the figure.

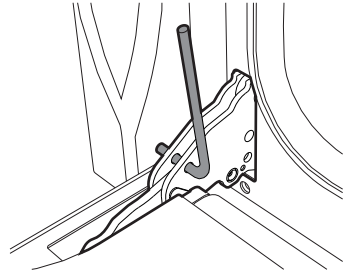

2. Grasp the door on both sides with both hands, lift it forming an angle of around 30° and remove it.

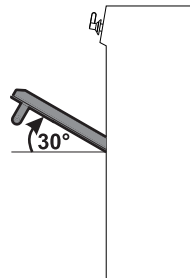

3. To reassemble the door, put the hinges in the relevant slots in the oven, making sure that grooved sections **A** are resting completely in the slots. Lower the door



Cleaning and maintenance

and once it is in place remove the pins from the holes in the hinges.

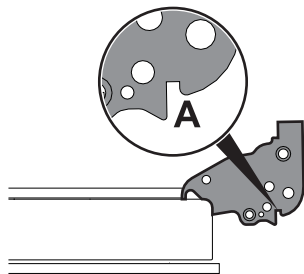

2. Then, pull the bottom part upwards (2). In this way, the 4 pins attached to the glass detach from their housings in the oven door.

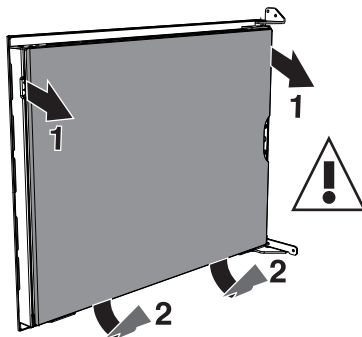

4.4 Cleaning the door glazing

The glass in the door should always be kept thoroughly clean. Use absorbent kitchen roll. In case of stubborn dirt, wash with a damp sponge and an ordinary detergent.



We recommend the use of cleaning products distributed by the manufacturer.

3. Hold the intermediate glass pane and unscrew the screw to remove the lower plate holding it in place.

4.5 Removing the internal glass panes

For easier cleaning the door internal glass panes can be disassembled.

Multifunction oven doors

1. Remove the internal glass pane by pulling the top part gently, following the movement indicated by the arrows (1).

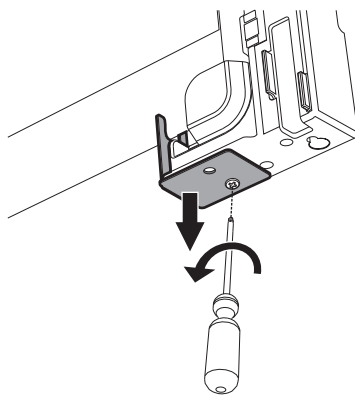

Improper use
Danger of cuts and glass crack

- Pay attention to the intermediate glass pane that could accidentally come out of its seat during this phase.



4. Remove the intermediate glass pane. First raise it upwards (1) and then remove it by pulling it downwards (2).

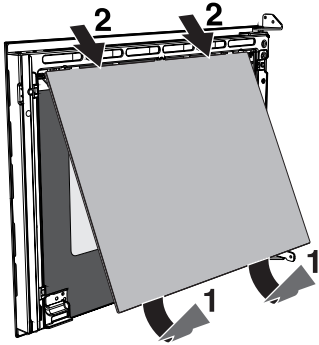

5. Clean the external glass pane and the panes previously removed. Use absorbent kitchen roll. In case of stubborn dirt, wash with a damp sponge and neutral detergent.

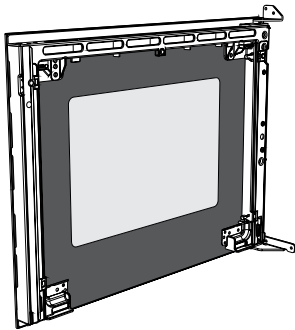

6. Refit the panes in the reverse order in which they were removed.

7. Reposition the internal glass pane. Take care to centre and insert the 4 pins into their housings in the oven door by applying slight pressure.

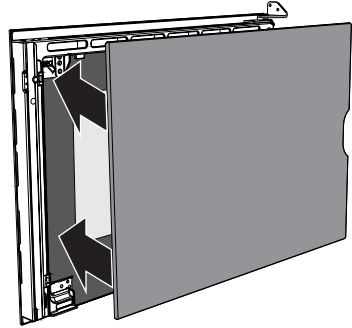

Auxiliary oven door

1. Remove the internal glass pane by pulling the rear part gently upwards, following the movement indicated by the arrows (1).
2. Then, pull the front part upwards (2). In this way, the 4 pins attached to the glass detach from their housings in the oven door.

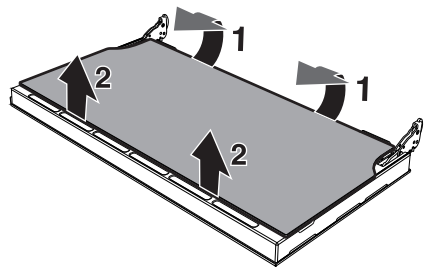



Cleaning and maintenance

3. Remove the intermediate glass pane by lifting it upwards.

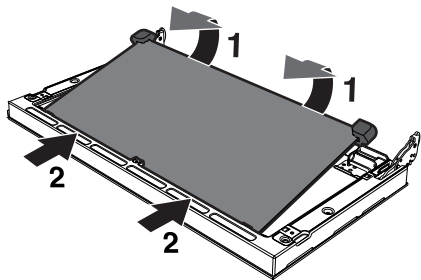

4. Clean the external glass pane and the panes previously removed. Use absorbent kitchen roll. In case of stubborn dirt, wash with a damp sponge and neutral detergent.

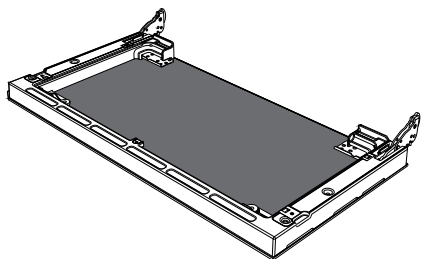

5. Refit the panes in the reverse order in which they were removed.
6. Reposition the internal glass pane. Take care to centre and insert the 4 pins into their housings in the oven door by applying slight pressure.

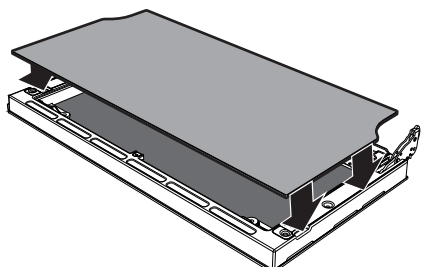

4.6 Cleaning the inside of the oven

For the best oven upkeep, clean it regularly after having allowed it to cool.

- 1 Take out all removable parts.



- 2 Clean the oven racks with warm water and non-abrasive detergent. Carefully rinse and dry damp parts.



The oven should be operated at the maximum temperature for about 15-20 minutes after the use of specific products, to burn off the residues left inside the oven.



For easier cleaning, remove the door.



Removing racks/trays support frames

Removing the guide frames enables the sides to be cleaned more easily. This operation should be performed each time the automatic cleaning cycle is used (on some models only).

To remove the guide frames:

- Pull the frame towards the inside of the oven to unhook it from its groove **A**, then slide it out of the seats **B** at the back.
- When cleaning is complete, repeat the above procedures to put the guide frames back in.

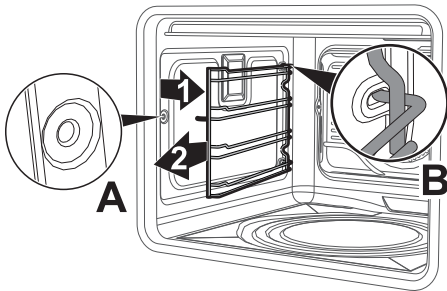

4.7 Vapor Clean: assisted oven cleaning



Vapor Clean is an assisted cleaning procedure which facilitates the removal of dirt. Thanks to this process, it is possible to clean the inside of the oven very easily. The dirt residues are softened by the heat and water vapour for easier removal afterwards.



Improper use
Risk of damage to surfaces

- Remove any food residues or large spills from previous cooking operations from the inside of the oven.
- Carry out assisted oven cleaning operations only when the oven is cold.

Preliminary operations

Before starting the Vapor Clean function:

- Completely remove all accessories from inside the oven. The upper guard can be left inside the oven.
- Pour approx. 40 cc of water onto the floor of the oven. Make sure it does not overflow out of the cavity.



Cleaning and maintenance

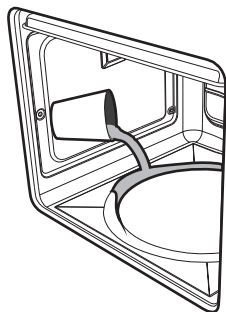

- Spray a water and washing up liquid solution inside the oven using a spray nozzle. Direct the spray against the side walls, upwards, downwards and towards the deflector.

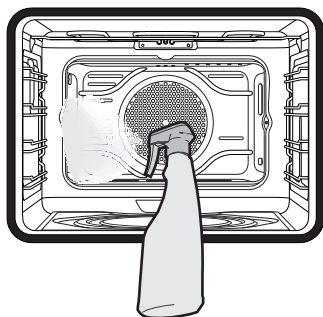

- Close the door.



We recommend spraying approx. 20 times at the most.

3. The Vapor Clean cycle starts approximately 6 seconds after the last pressure on the programmer's keys.
4. At the end of the Vapor Clean cycle, the timer will deactivate the oven heating elements, the buzzer will start to sound and the numbers on the dial will flash.

End of the Vapor Clean cycle

1. Open the door and wipe away the less stubborn dirt with a microfibre cloth.
2. Use an anti-scratch sponge with brass filaments on tougher encrustations.
3. In case of grease residues use specific oven cleaning products.
4. Remove the water left inside the oven.

For improved hygiene and to avoid food being affected by any unpleasant odours, we recommend that the oven is dried using a fan assisted function at 160°C for approximately 10 minutes.



We recommend wearing rubber gloves for these operations.



For easier manual cleaning of the parts difficult to reach, we recommend removing the door.

Vapor Clean setting

1. Turn the function knob and the temperature knob to the  symbol.
2. Set a cooking duration of 18 minutes using the cooking duration procedure described in more detail in "Programmed cooking".



4.8 Extraordinary maintenance



Live parts
Danger of electrocution

- Disconnect the oven power supply.

Replacing the internal light bulb

1. Completely remove all accessories from inside the oven.
2. Remove the racks/trays support frames.
3. Remove the bulb cover using a tool (e.g. a screwdriver).

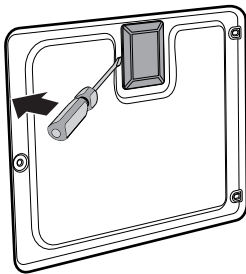

4. Unscrew and remove the lamp.

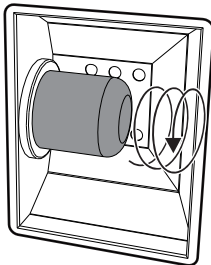

5. Replace the lamp with one of the same type (25W).

6. Refit the cover correctly, so that the moulded part of the glass is facing the door.
7. Press the cover completely down so that it attaches perfectly to the bulb support.

Removing the seal of the auxiliary oven

To permit thorough cleaning of the auxiliary oven, the door seal can be removed. There are hooks on all four sides to attach it to the edge of the oven. Pull the edges of the seal outwards to detach the hooks.

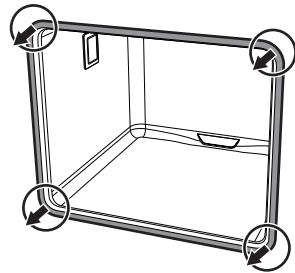

To keep the seals clean, use a non-abrasive sponge and lukewarm water. Seals should be soft and elastic.



Installation

5 Installation

5.1 Electrical connection



**Power voltage
Danger of electrocution**

- Have the electrical connection performed by authorised technical personnel.
- Use personal protective equipment.
- The appliance must be connected to ground in compliance with electrical system safety standards.
- Disconnect the main power supply.
- Do not pull the cable to remove the plug.
- Use H05V2V2-F cables withstanding a temperature of at least 90°C.
- The tightening torque of the screws of the terminal supply wires must be 1.5 - 2 Nm.

The appliance can work in the following modes:

- **220-240 V 1N~**

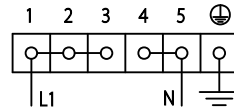

Use a **3 x 10 mm² three-core** cable.

- **380-415 V 2N~**

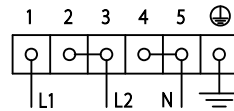

Use a **4 x 6 mm² four-core** cable.

- **380-415 V 3N~**

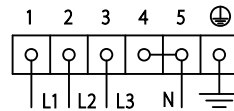

Use a **5 x 4 mm² five-core** cable.

General information

Check that the mains electricity supply matches the characteristics indicated on the identification plate.

The identification plate bearing the technical data, serial number and brand name is visibly positioned on the appliance. Do not remove the identification plate for any reason.

Perform the ground connection using a wire that is 20 mm longer than the other wires.



The values indicated above refer to the cross-section of the internal conductor.



The aforementioned power cables are sized taking into account the coincidence factor (in compliance with standard EN 60335-2-6).



In the event of connection to a two- or three-phase supply, the installed clamp must be replaced with the one supplied in order to ensure correct fastening of the cable.

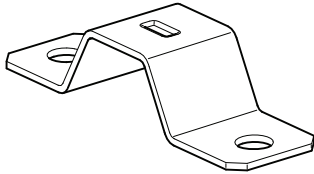

Fixed connection

Fit the power line with an omnipolar circuit breaker in compliance with installation regulations.

The circuit breaker should be located near the appliance and in an easily reachable position.

Connection with plug and socket

Make sure that the plug and socket are of the same type.

Avoid using adapters and shunts as these could cause overheating and a risk of burns.

5.2 Positioning



Heavy appliance
Danger of crushing injuries

- Position the appliance into the cabinet cutout with the help of a second person.



Pressure on the open door
Risk of damages to the appliance

- Never use the oven door to lever the appliance into place when fitting.
- Avoid exerting too much pressure on the oven door when open.



Heat production during appliance operation
Risk of fire

- Veneers, adhesives or plastic coatings on adjacent furniture should be temperature-resistant (no less than 90°C).



Installation

General information

This appliance may be installed next to walls, one of which must be higher than the worktop, at a minimum distance of 50 mm from the side of the appliance, as shown in figures A and C relative to the installation classes.

Any wall units positioned above the worktop must be at a minimum distance of at least 750 mm. If a hood is installed above the hob, refer to the hood instruction manual to ensure the correct clearance is left.

Depending on the type of installation, this appliance belongs to classes:

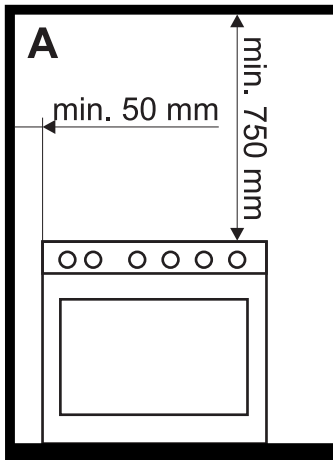

A - Class 1
(Free-standing appliance)

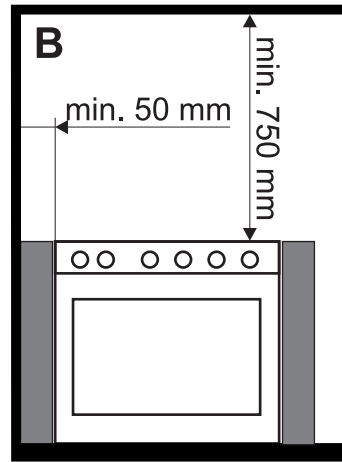

B - Class 2 subclass 1
(Built-in appliance)

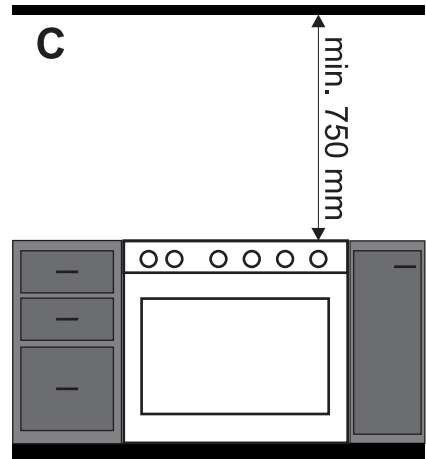

C - Class 2 subclass 1
(Built-in appliance)



The appliance must be installed by a qualified technician and according to the regulations in force.



Assembling the upstand

i The upstand provided is an integral part of the product; it must be fastened to the appliance prior to installation.

The upstand must always be positioned and secured correctly on the appliance.

1. Loosen the 4 screws (**A**) on the back of the hob (2 for each side) using a screwdriver.
2. Place the upstand on the worktop.
3. Align the slots of the upstand (**B**) with the screws (**A**).

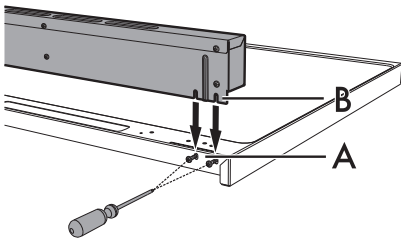

4. Secure the upstand to the worktop by tightening the 4 screws previously loosened.

Mounting the toe skirt

i The toe skirt provided is an integral part of the product; it must be fastened to the appliance prior to installation.

The toe skirt must always be positioned and secured correctly on the appliance.

1. Place the toe skirt in the front bottom part of the appliance.
2. Screw the two side screws to fasten the toe skirt to the appliance.
3. Cover the holes of the toe skirt with the plugs provided.

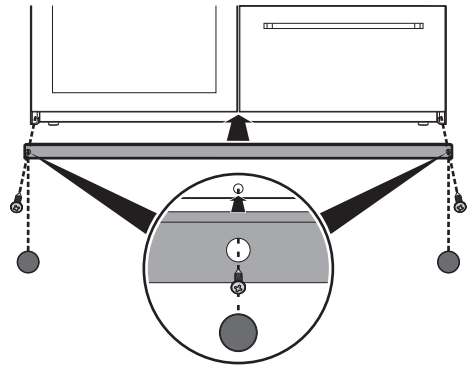



Positioning and levelling the appliance

After making the electrical connections, properly level the appliance on the floor to ensure better stability:

- Screw or unscrew the bottom part of the foot until the appliance is stable and level on the floor.

